

B13

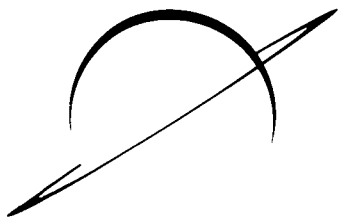

INSTRUCTION BOOK DEPT.
LIBRARY
MASTER COPY

ZANUSSI

Instructions for the use and care of EC 28 cooker

B13

Contents

Instructions for the owner

Installation	Page 4
Technical data	Page 5
Use and care	Page 6
Using the oven	Page 9
Analogue clock	Page 10
General hints	Page 11
Upkeep and cleaning	Page 13

Instructions for the installer

Installation	Page 16
Electrical connection	Page 17
What happens if something goes wrong	Page 18

Caution

Before you start operating the appliance, be sure to remove the plastic films protecting the stainless steel or anodized aluminium parts.

Instructions for the owner

Installation

It is mandatory that all operations required for the installation be carried out by **QUALIFIED PERSONNEL** in accordance with existing rules and regulations.

The relevant instructions are to be found in the special chapter for the installer.

Warning

During normal cooking the oven heats up considerably at the level of the glass window of the door and other adjacent parts. That is why one should make sure that children do not touch the oven.

Important

If other home appliances are connected to sockets that are very close to the oven, make sure that the supply cord of the appliance does not come in touch with burning hot plates or heat areas and, furthermore, that it does not get stuck in the hot oven door.



A0186

Technical data

Dimensions:

Height	mm. 900
Depth	mm. 598
Width	mm. 597
Oven capacity	cu.dm. 54

Hob

Rear left dia.	mm. 145 (N)	1000 W
Front left dia.	mm. 180 (R)	2000 W
Rear right dia.	mm. 180 (N)	1500 W
Front right dia.	mm. 145 (N)	1000 W
Maximum power absorbed		5.5 kW

Oven

Lower element	1.0 kW
Upper element	1.0 kW
Grill element	2.0 kW
Oven lamp	15 W
Maximum power absorbed	2.015 kW
Power Supply (50 Hz)	240 V
Total power	7.515 kW

N = Normal electric cooking plate;

R = Rapid electric cooking plate.

This appliance meets the requirements laid down in EEC Directive No. 82/499 dated 7/6/1982 relating to the suppression of radio and TV interferences.

Use and care

- A - Hob with electric plates
- B - Control panel
- C - Side grilles
- D - Grilles
- E - Oven door
- F - Removable drawer
- G - Front panel
- H - Removable base

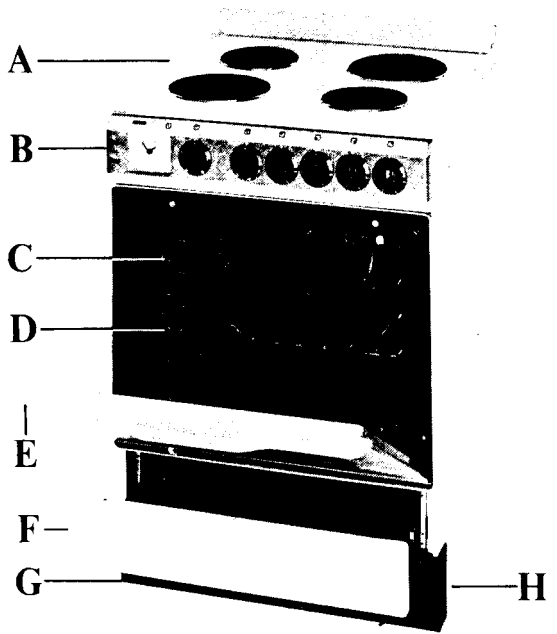

- I - Dripping pan, large
- J - Reversible grill pan insert
- K - Removable handles (2 Off.)

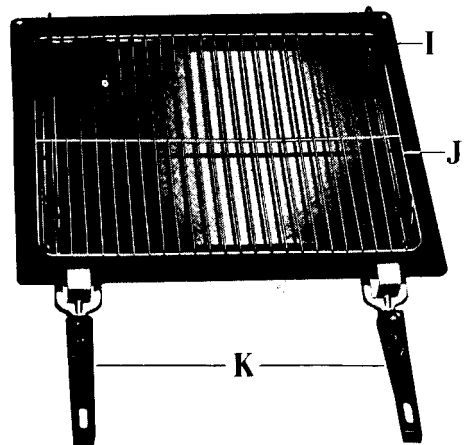

Control panel

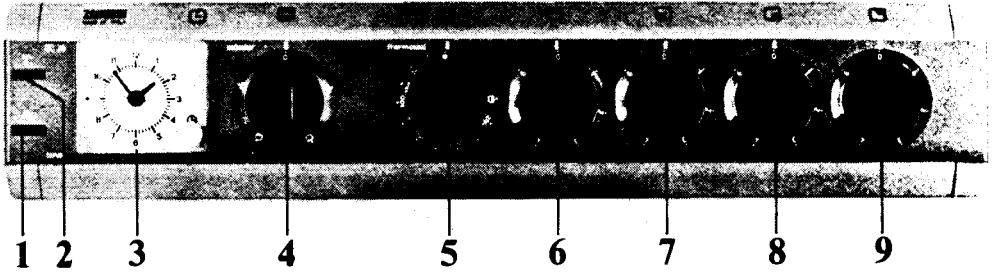

- 1 - General control light
- 2 - Thermostat control light
- 3 - Analogue clock
- 4 - Oven selector knob
- 5 - Oven thermostat knob
- 6 - Rear left heat zone control knob
- 7 - Front left heat zone control knob
- 8 - Front right heat zone control knob
- 9 - Rear right heat zone control knob

Operation

Electric plates

The control panel includes knobs for operating the four heating elements on the hob.

The plates are controlled by a switch (Fig. 1) by means of a 6-position knob:

0 = Off

1 = Minimum electric plate power

6 = Maximum electric plate power

Increased power values are given by intermediate positions 2, 3, 4, 5 respectively.

Important

During cooking on the hob when fats or oils are used pay particular attention since these may overheat and consequently flare up.

Useful hints

Maximum service life of the electric plates and saving of electric energy can be achieved by taking following precautions:

use only pots and pans with a flat bottom and having a diameter at least equal to that of plates;

avoid boiling liquids spilling from pots or pans on to the electric plates;

never leave the electric plates switched on without a pot or a pan on them or only with an empty pot or pan on them.

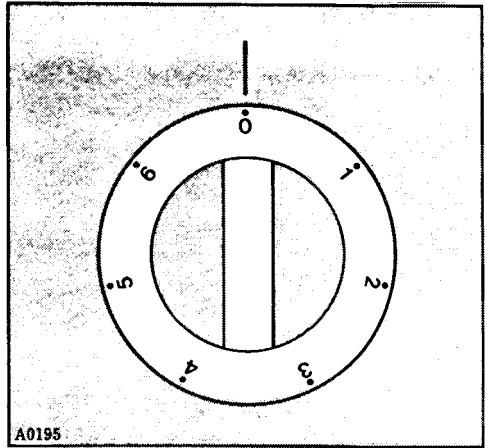

Fig. 1

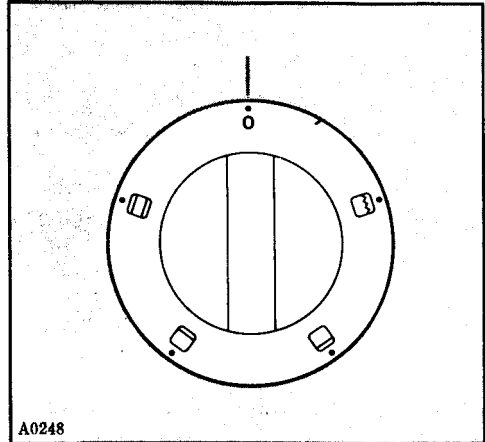

Fig. 2

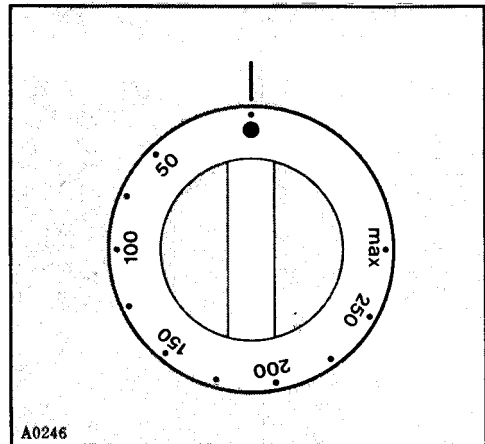



Fig. 3

Using the oven

Important

Caution must be taken when the grill is used and children must be kept away during its operation.



Preheat the oven, arrange the food in the oven, shut the door and turn the selector knob (Fig. 2) to symbol ; turn then the thermostat knob (Fig. 3) to the required temperature.

Heat comes from the top and from the bottom, therefore it is preferable to use the central runner.

By turning the selector knob to position  the oven light will come on; this operation will also maintain the general control light on until the knob is turned again to position «0». The cooking positions of the thermostat knob (Fig. 3) are the positions from 50° to MAX and give a full range of temperatures.

The oven temperature light will come on and will remain on until the oven has reached the correct temperature; after that it will come off and on showing how the temperature is being maintained.

If cooking requires more heat from the bottom or from the top use the bottom or the top runners.

Turn the oven selector knob to symbol  for bottom heating or to symbol  for top heating.

When the oven control reaches  the bottom element comes on and a max. temperature of 230°C can be obtained.

When the oven control reaches , the top element comes on and a max. temperature of 240°C can be obtained.

These settings are particularly useful for finishing food either only on the top or the bottom.

During cooking, the door should be opened as little as possible to avoid heat loss and so excessive electricity consumption.

The oven has a removable grill.

The grill cannot be used at the same time as the oven.

Using the grill

Turn the oven selector knob (Fig. 2) to .

Turn the oven grill regulator knob (Fig. 3) to the required temperature.

As with the oven the grill control (see Fig. 3) can be set to a number of different heat settings.

At «max» position the maximum temperature is obtained.

Foods to be grilled are placed on the wire grid in the grill pan, which can be adjusted on the side grids either upwards or downwards to give the required distance from the element.

For foods which require a longer grilling, the grill pan has to be set on the lower positions.

Important

To spare energy, the oven door must be closed during grilling.

Analogue clock

By turning the knob A (Fig. 4) clockwise or anticlockwise, the analogue clock will show on dial B the required cooking time (max. 180 mins).

When setting a cooking time a sound signal will indicate that the cooking is over.

To stop it turn knob A clockwise until symbol «0» coincides with the index of dial B.

By pulling and turning the knob A either clockwise or anticlockwise you can reset the clock to correct time (f.i. upon installation, following a power failure or when the clock is fast or slow, etc.).

Safety thermostat

Should the main oven thermostat fail the oven is protected by a safety thermostat which will operate if the temperature within the oven reaches too high a level. Once the temperature has returned to a safe level the main oven thermostat will function.

In cases where there is a permanent failure it is necessary to contact the Zanussi Network Service Engineer.

General hints

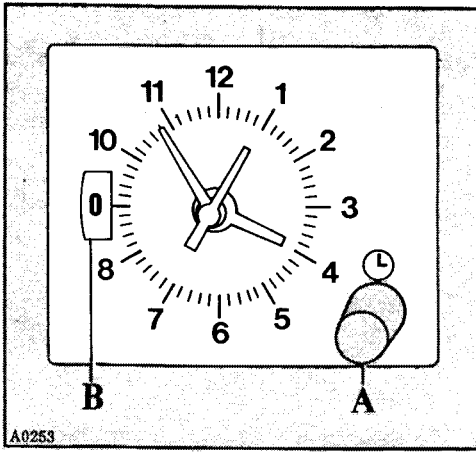

Fig. 4

Use flat-bottom pots and pans which have a diameter equal to that of the electric plates (Fig. 5). Flat-bottom pots enable energy saving and increase the service life of the electric plates.

Follow instructions provided by the pots and pans manufacturer on their use. Save energy by using pots of the appropriate diameter, avoiding to select temperatures higher than those necessary and by exploiting the residual heat present on plates when they are turned off.

Temperature of the electric plates may be reduced if pots and pans are provided with a cover.

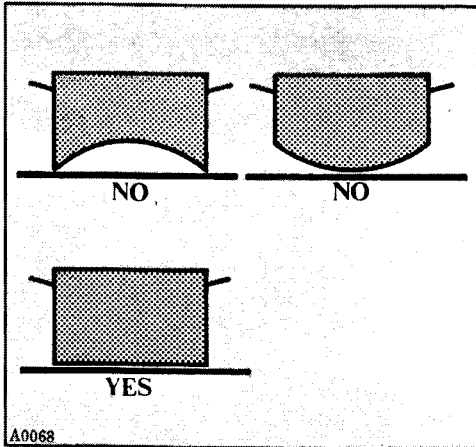

Fig. 5

Hints for a correct use of the oven and the grill

Whipped up kneadings have the required firmness when they tend to stick to the spoon as, otherwise, an excessive fluidity would uselessly stretch the cooking time. Shortbread kneadings should first be baked in the mould or in the baking-tin for about two-thirds of the total baking time, and then be garnished (trimmed) before you complete the baking. This final baking time depends on the type and quantity of the garniture (trimmings).

Gourmets greatly appreciate grilled food as it usually remains very tender and savoury. All meats are suitable for grilling, with the exception of some lean game meats and meat-loaves.

The meat must be thoroughly drained, i.e. kept until it becomes high (tender). The pieces of meat to be cooked should not weigh less than 1 Kg. boneless.

If bones are removed beforehand, this will shorten the cooking time and it will be easier to cut the meat.

Ingredients for the gravy should be placed in the baking-tin straightaway if cooking is to be short. If cooking is to last long, instead, these ingredients are to be added during the last half-hour. To find out if the meat is done, press it down with a spoon.

If it is well done the meat should not give in (yield). When the meat is done to a turn, the gravy is grayish in colour. Cooking time for roast-beef and fillet, the inside of which should remain of a pink colour, is reduced.

Wait for at least 15 minutes before cutting the meat, so that the dish gravy (meat juice) may settle down instead of dripping out profusely.

The dish can be kept warm in the oven with the thermostat turned off.

Important

The anti-tip oven grid must be positioned as shown in Figure 6.

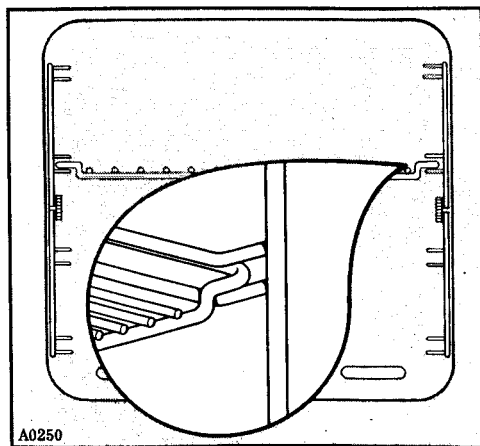

A0250
Fig. 6

Upkeep and cleaning

For a long service life of the appliance, we strongly recommend that you frequently carry out a thorough cleaning operation. All operations must be carried out when the appliance has cooled.

Important

Before undertaking any cleaning or upkeeping operation, be sure to have the appliance disconnected from the electric supply.

Cleaning the electric plates

Avoid discolouring of the electric plates by cleaning them after use with water and a detergent and then wipe them with a cloth soaked with a window cleaning liquid.

Never use steel wool pads since they damage the antirust coat on the electric plate and it scratches the surrounding enamel.

Electric plates which remain unused for long periods of time, such as in second houses, or which operate in salty or vapour saturated environments may become rusty.

In these cases the anti-rust coat must be renewed using the appropriate products available on the market.

Cleaning the oven

Always wait until the oven is cool before cleaning.

All enamelled parts should be washed with lukewarm water and detergent without using abrasive products which might damage them.

The oven should be cleaned inside with the greatest care, after each use, with hot water and detergent (or one of the special products available on the market).

When cleaning the oven, be careful to protect the aluminium parts of the control panel from chemical compounds contained in the products used to clean the enamelled parts.

Removing the panels (optional)

Unscrew the ring nuts securing the side grilles (Fig. 7), remove the grilles and then remove the side panels (Fig. 8).

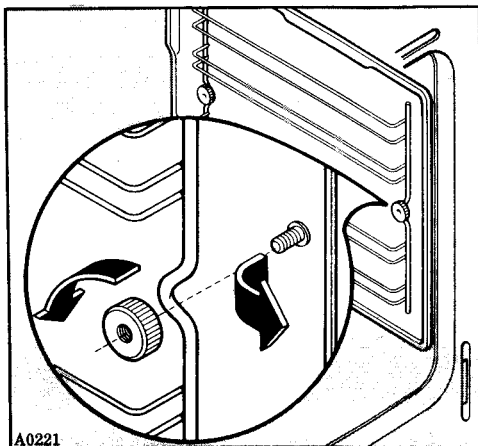

A0221

Fig. 7

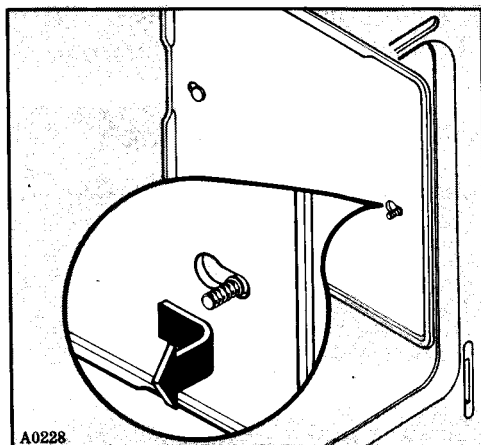

A0228

Fig. 8

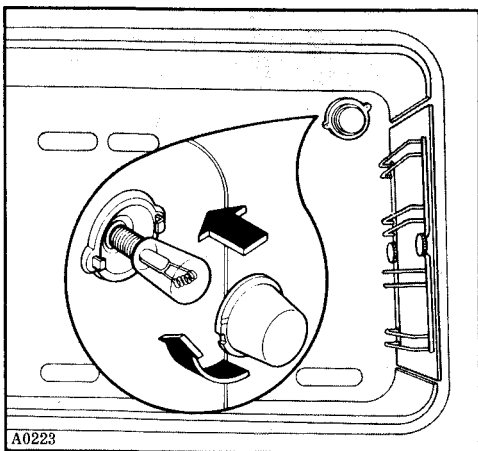

A0223

Fig. 9

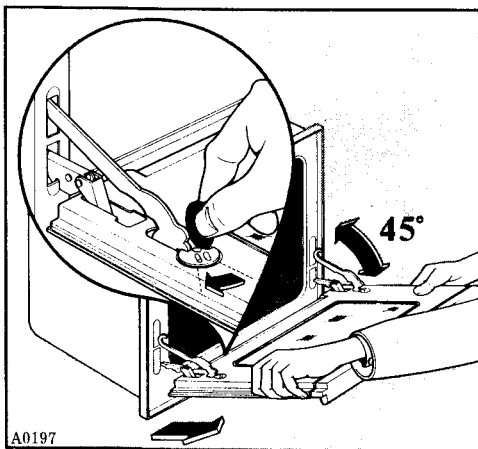

A0197

Fig. 10

Replacing appliance components

Prior to undertaking any maintenance work or replacing the oven lamp or grill heating element, be sure to disconnect the appliance from the electric supply.

1. Control Knobs

These can be removed by pulling them out.

2. Oven lamp replacement

Unscrew glasscap (Fig. 9) and replace burnt-out bulb with one that resists to high temperatures (300°C).

Electric bulb: 15W, 240V, 50Hz, 300°C. E14.

Removing the oven door

To thoroughly clean the oven you should remove the door by proceeding as follows:

1. With the aid of a coin, turn the oven door stops (catches) 45° to the right.
2. Raise the door to the limit stop and pull it out in a forward direction (Fig. 10). Grasp the door on the two sides - don't pull it by the handle!

To re-install the door:

1. Insert the door into the oven with its two brackets.
2. Open the oven door and return the door stops (catches) to their original position.

Instructions for the installer

Installation

The following instructions are meant for a qualified installer and should assist him in carrying out all installation, adjustment and maintenance operations in the most correct way and in accordance with existing laws and regulations.

Important

Before servicing the appliance or undertaking any maintenance work on it, be sure to disconnect it from the electric supply. Should it be absolutely necessary to keep the appliance «live» take all possible precautions to prevent accidents.

Fitting the splash back

Take from the dish-warming drawer the aluminium splash back; remove its protecting film and fix it as shown in Figure on page 6.

Positioning

To ensure a troublefree operation of the appliance, it is a must that it be set up in a well ventilated kitchen (in this connection, the installer needs only comply with existing rules and regulations).

The cooker may be positioned in such a way as to come into touch with the sides of the kitchen furniture. However, the latter must be able to withstand a temperature increase of 60°C.

The appliance incorporates a removable base (A - Fig. 11-12) which permits the alignment with kitchen furniture having a height of 85 cms, plus levelling feet (B - fig. 11-12).

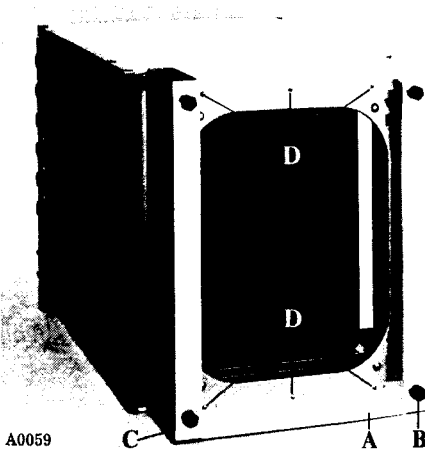

A0059
Fig. 11

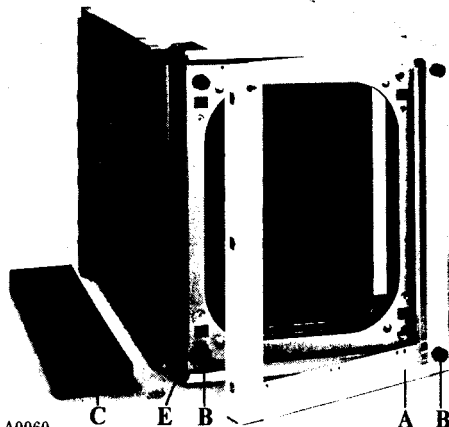

A0060
Fig. 12

Electrical connection

To remove the metal base rest the appliance on a side, slide out the front plastic panel (C - Fig. 11) which is push-fitted and then unscrew the six screws (D - Fig. 11) that secure the base to the cabinet.

Removing the levelling feet from the base (B - Fig. 11-12), screw them onto the cabinet and then fit the new front panel (optional) (E - Fig. 12).

Position the appliance.

The appliance incorporates a set of adjustable feet.

By properly adjusting the feet, the appliance can be set up at the required height and correctly aligned with the kitchen furniture or any other surface, thus ensuring an even spreading out of liquids in pans and pots.

These adjustable feet are easily accessible after removing the dish-warming drawer.

To remove this drawer, proceed as follows:

pull out the drawer to the limit stop in order to slide out completely the side runners;

shift the front rollers up to the slots of the side runners;

lift up the drawer and slide out the front rollers;

pull out the drawer and shift the rear rollers up to the slots of the side runners;

lift up the drawer and slide out the rear rollers.

To replace the drawer, reverse the above procedure.

The appliance is designed to operate on alternating current, with a single phase voltage of 240 V - 50 Hz.

The electric supply cable has to be connected to the terminal board placed under the cover on the back of the appliance.

The oven terminal board has the following markings:

L = Live
N = Neutral
⊕ = Earth

The ground wire has to be green & yellow coloured.

If you require a direct connection to the electric network (mains), it will be necessary to fit between the cooker and the mains an omnipole switch, with a minimum aperture between contacts of 3 mm, suitable to carry the required load and conforming to the ruling specifications.

The green & yellow ground wire must not be interrupted by the switch.

The supply cable must at any rate be placed in such a way as to ensure that it does not reach at any given point a temperature 50°C higher than the ambient temperature.

Prior to connecting the cooker to the electricity supply make sure that:

the protection fuse and the domestic wiring are suitable to carry the total electric load of the cooker (see rating plate);

the electricity supply network (mains) has an efficient earth connection according to the established rules and existing regulations;

with the cooker definitely installed, the wall socket or the omnipole switch can easily be reached.

The Manufacturer disclaims any liability in case these accident-preventing rules are not observed.

The heat insulation of the oven and grease residues from the manufacturing process produce smoke and an unpleasant smell during the first minutes of operation.

It is therefore advisable, the first time the appliance is used, to pre-heat the oven for about 30 mins. at peak temperature without putting any food into it.

What happens if something goes wrong

If the cooker does not come on:

check that it is plugged in properly;

check that the socket switch and/or the switch from the supply to the oven are ON;

replace the fuse in the plug, when present, with another of the appropriate rating and check that this plug has been wired up properly;

check that the socket, when present, is supplying power - do this by plugging in another appliance that is known to be working properly;

check that the fuse in the fuse box is intact.

If, after all these checks, the oven still does not work, send for your local Zanussi network service centre listed in the telephone directory.

It helps to jot down the name and address and telephone number in the space below.



ZANUSSI STANDARD GUARANTEE CONDITIONS

This guarantee is in addition to your statutory and other legal rights which will not be excluded or in any way diminished by the return of the guarantee card.

We, IAZ International (UK) Ltd, undertake that if, within twelve months (24 months for TV sets) of the date of the purchase, this ZANUSSI appliance or any part thereof is proved to be defective by reason only of faulty workmanship or materials, we will, at our option, repair or replace the same **FREE OF ANY CHARGE** for labour, materials or carriage on condition that:

—The appliance has been correctly installed and used only on the electricity supply stated on the rating plate.

—The appliance has been used for normal domestic purposes only, and in accordance with the manufacturer's operating and maintenance instructions.

—The appliance has not been serviced, maintained, repaired, taken apart or tampered with by any person not authorised by us.

—The appliance is still in the possession of the original purchaser.

All service work under this guarantee must be undertaken by a Zanussi Network Service Centre (or the Zanussi Authorised TV Service Dealer).

Any appliance or defective part replaced shall become our property.

Exclusions

This guarantee does not cover:

—Damage or calls resulting from transportation, improper use or neglect, the replacement of any light bulbs or removable parts of glass or plastic.

—Costs incurred for calls to put right machines improperly installed or calls to machines outside the UK and the Republic of Ireland.

—Appliances found to be in use within a commercial environment, plus those which are the subject of rental agreements.

—Television receivers - routine adjustment, or poor reception resulting from a source outside of the receiver.



ZANUSSI 5 YEAR COVER CONDITIONS

For a once-only payment you can extend your Standard Guarantee to 5 years. All the conditions and exclusions of the Standard Guarantee apply.

Notes

1. Products supplied as "seconds", refurbished, damaged or shop-soiled are not eligible for Zanussi 5 year cover.
2. The issue of a cover does NOT by virtue of our having done so, nullify the exclusions.
3. The Engineer will need to check the details of your Cover card and may make a charge for his services if it is not presented to him at the time of his call.
4. The date of purchase, or the date of initial payment (deposit) of the appliance will be deemed the date of commencement of cover.
5. Covers issued are not refundable or transferable.

ZANUSSI
The appliance of science